

Keysight N9320B RF Spectrum Analyzer



All the essentials of a Keysight spectrum analyzer
with a price/performance that's easy to afford

Keysight N9320B Spectrum Analyzer – Built to Perform, Priced for you to Compete

Regardless of whether your application is electronics' manufacture, bench repair, R&D projects, or RF related education, you need a spectrum analyzer that is equipped with the essential functionality and required performance at an affordable price. The Keysight Technologies, Inc. N9320B is designed to be the right answer for you.

Spectrum analysis from 9 kHz to 3 GHz:

- Measurement speed:
Minimum non-zero span sweep time: 10 ms
- RBW:
10 Hz to 1 MHz in 1-3-10 steps
- DANL:
-148 dBm with preamp

Robust measurement features for characterizing your product easily:

- Built-in power measurements: Channel power, OBW, ACP, SEM and TOI
- Built-in power meter function with Keysight U2000 series power sensor support
- Optional tracking generator and preamplifier
- Remote control PC software

Power measurement and automated test programming features

- The accuracy of frequency selective power measurements when characterizing your products is very important. With a newly featured digital IF, the N9320B enables dramatic improvements in power measurement accuracy.
- Power meter functionality is also built-in with Keysight Technologies, Inc. U2000 series power sensor support for highly accurate RF and MW power measurements.
- The built-in 1-button power measurement suite offers channel power, ACP, OBW, SEM and TOI measurements.
- For automated test programming, the N9320B provides industry standard SCPI language support and flexible connectivity choices with USB, LAN and GPIB. Plus, SCPI code compatibility with Keysight ESA-L series for easy instrument replacement.

Engineered for the best spectrum visibility

In your R&D, QA or university research lab, you want to know as much measurement detail as possible about your products and designs. The N9320B offers the best-in-class spectrum visibility. The 10 Hz minimum RBW distinguishes closely spaced signals easily, the -148 dBm DANL reveals low level signals clearly, and combined with the 4 trace display and 12 markers allows you to easily identify and compare signal details.

Integrated solution for the modern RF teaching lab

One of the best ways to improve students' learning efficiency for RF related curriculums is to combine lectures with hands-on labs. The N9320B is an excellent price-performance fit for educational purposes. Whether you wish to combine the N9320B analyzer with the Keysight N9310A RF signal generator for basic RF concept labs, or enhance your RF circuit labs with the N9320B and its optional RF training kit (option code: N9320B-TR1), you will find adopting Keysight's RF education solution efficient and effective.

Keysight N9320B Spectrum Analyzer – Built to Perform, Priced for you to Compete (continued)

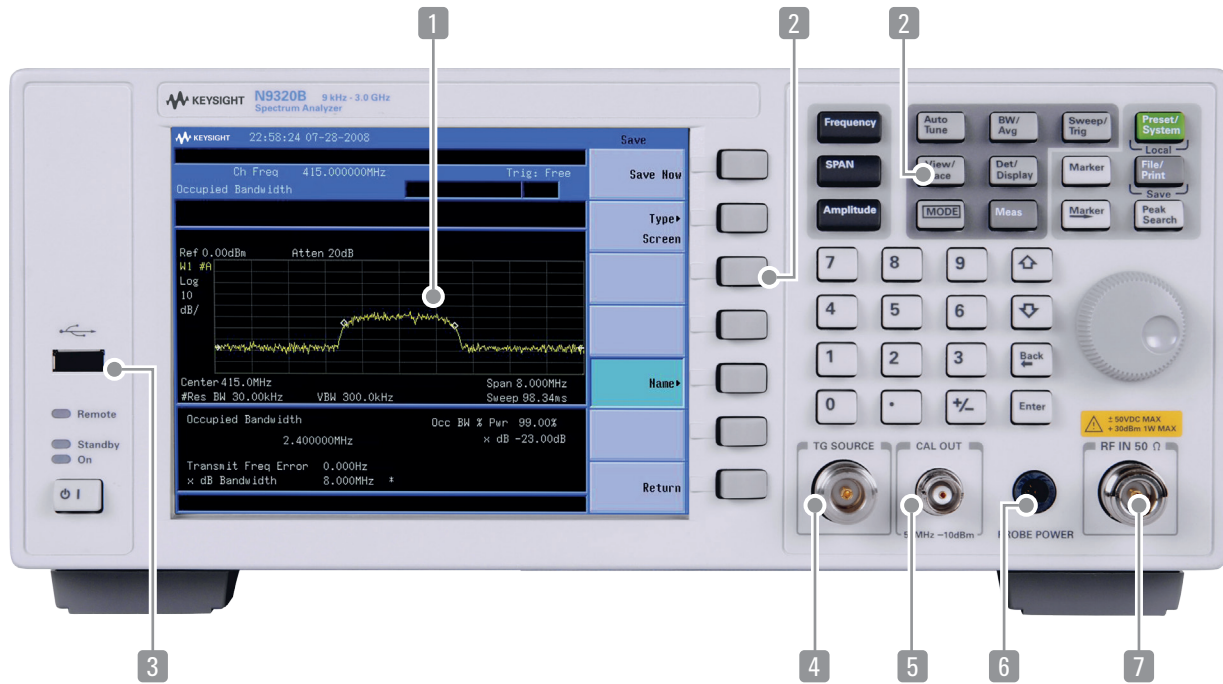

1. 6.5-inch high resolution screen provides vivid spectral view from any angle
2. Logically arranged function keys and soft keys provides intuitive access for each operational step
3. USB interface offers convenient data storage via USB flash disk
4. Tracking generator output enables frequency response measurement
5. Cal Out (50 MHz, -10 dBm)
6. Probe power for high impedance RF probes
7. RF input (N type, female)

What's New on N9320B?

| New features | Overview | Option number |
|--|---|------------------|
| AM/FM demodulation metrics | Offers modulation data, including carrier power, modulation rate, AM depth or FM deviation, SINAD and carrier frequency offset | N9320B-AMA |
| ASK/FSK demodulation metrics | Provides four display modes: symbol, waveform, ASK/FSK error and eye diagram | N9320B-DMA |
| EMI filter | Provides 200 Hz, 9 kHz, 120 kHz and 1 MHz RBW bandwidth (6 dB down) | N9320B-EMF |
| Power meter function | When connection with a Keysight U2000 series USB power sensor, the N9320B can be used as a power meter for high accuracy power measurements | Standard feature |
| SCPI command compatibility for Keysight ESA-L series | Able to distinguish and interpret Keysight ESA-L SCPI commands, reducing programming effort for ESA-L replacement with N9320B | Standard feature |
| LAN interface | Provides LAN connection for auto test or remote control | Standard feature |
| GPIB interface | Provides GPIB connection for automated test | N9320B-G01 |
| RF training kit | Special for educational purposes. The RF training kit consists of a transceiver trainer, control panel software and lab sheets | N9320B-TR1 |
| Remote control PC software | Controls the spectrum scans and transfers data between N9320B and a PC via USB/LAN/GPIB | Standard feature |

Keysight N9320B Spectrum Analyzer – Built to Perform, Priced for you to Compete (continued)

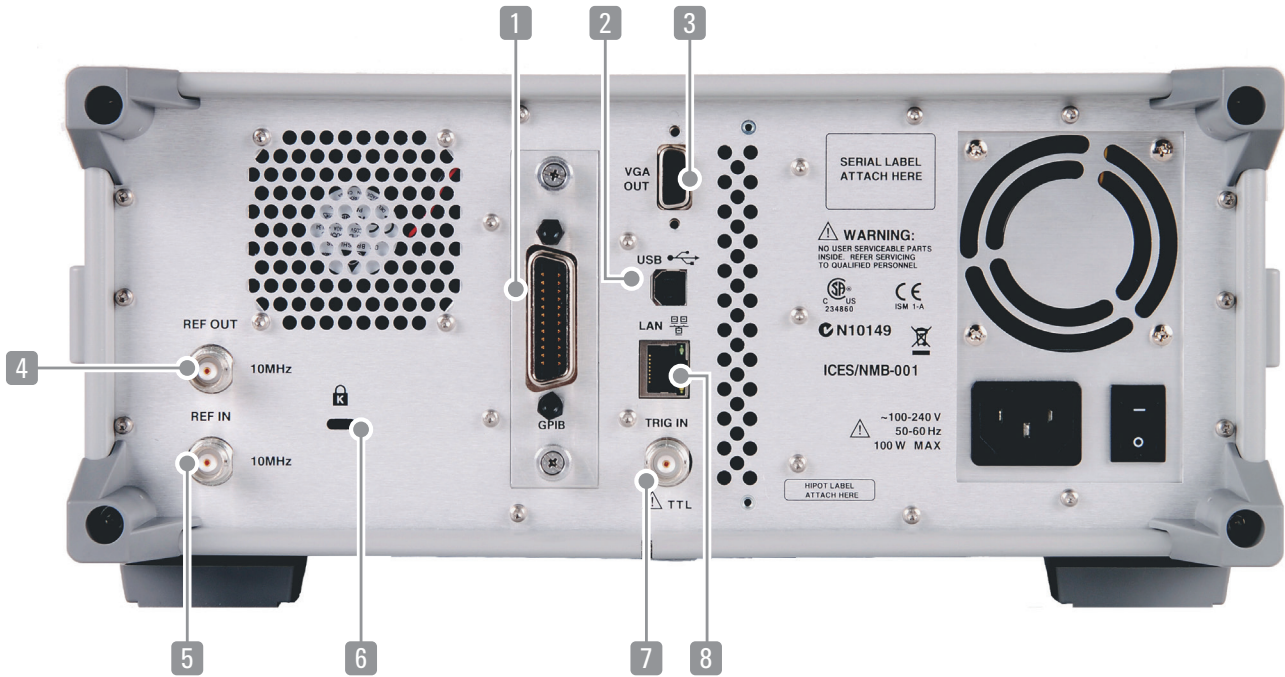

1. GPIB interface
2. USB interface
3. VGA display connector
4. Frequency reference output

5. Frequency reference input
6. Security Kensington lock
7. TTL trigger signal input
8. LAN port

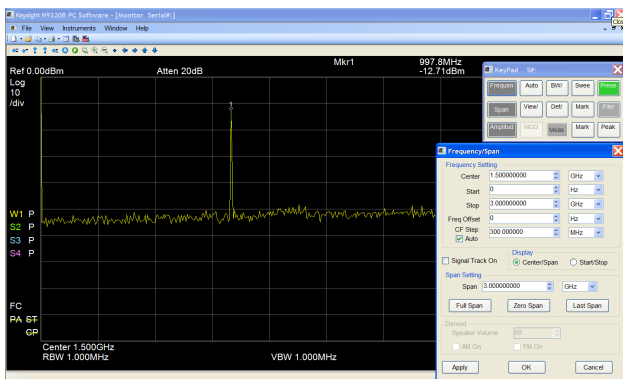

Remote control PC software



3U height easily fits into your test racks

Electronics Manufacturing

When you need faster and more cost effective RF analysis tools for testing today's consumer electronics products and components – look no further!

We have optimized the N9320B to meet your needs in performance and cost

- 10 ms minimum, non-zero span sweep time
- ± 1.5 dB overall amplitude accuracy, typical ± 0.5 dB
- 10 Hz minimum resolution bandwidth
- Sensitivity is -148 dBm DANL with preamplifier
- Multiple language user interface improves ease-of-use and reduces training time by utilizing your local language

Best-in-class performance ensures your test station is operating quickly without compromising quality



Accelerate time to market while simultaneously reducing costs.



Regardless of whether you are manufacturing a wireless mouse, keyboards, GPS devices, or RF components such as mixers, filters or amplifiers, you need to measure their RF characteristics to insure they work properly within their design parameters like frequency bandwidth and output power range. Too little RF power may decrease the wireless operating distance, while too much power can drain batteries quickly, reducing operation time and cause excessive heat in the device.

In today's competitive world, you need to verify your product's RF performance fast and accurately as well as lower your cost of ownership. The affordable N9320B is designed to help achieve all these goals. So, why not take a closer look at the N9320B spectrum analyzer?

Boost productivity by decreasing test time

The throughput rate of a test station is generally one of the key factors limiting the productivity of a manufacturing line. You almost always want to test your products in the shortest possible time. The sweep time of a spectrum analyzer is often the most important performance specification contributing to your RF analysis test time. The N9320B analyzer provides you with 10 ms non-zero span sweep time, the fastest in its class.

Testing and validating your products with confidence

The N9320B equipped with a new digital IF section tests your product with improved frequency and amplitude accuracy and stability. It provides essential information for your products' performance and characteristics with increased confidence.

Simplify Common Measurement Tasks



When you find yourself having repeatedly to make the same type of complex measurement or measurement sequence, it is useful to know that some shortcuts are available. That's what we have provided for you in the N9320B spectrum analyzer.

The N9320B spectrum analyzer continues the Keysight tradition that test equipment should be easy to set up and simple to use. Those familiar with other Keysight spectrum analyzers will find a similar user interface in the N9320B, allowing for a shorter learning curve and easier operation.

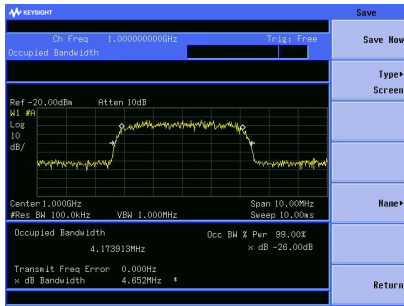

One button auto-tuning allows you to quickly find and accurately analyze the highest level signal anywhere in the analyzer's frequency range. Centering this signal on the screen, the analyzer simultaneously optimizes the frequency span, resolution and video bandwidths, auto-scales the amplitude, sets a marker on the signal peak and displays the measurement results.

Power measurements made easy using the one-button measurement suite

You will find that the one-button power measurement suite shortens routine test set up time by simplifying the keypad/menu selection.

Selecting these one-button routines directly from the softkey menu also helps ensure accuracy and repeatability of the test set up and measurement no matter who presses the button.

One of the most fundamental measurements performed by spectrum analyzers is the frequency domain measurement of RF power. However, detailed analysis of a signal often requires standards-defined spectral masks or more complex power/bandwidth/detector measurement combinations.

Channel power

Precise, rapid integrated channel power with computed power spectral density utilizing the RMS average detector.

Occupied bandwidth

Selecting the percentage of the signal's power to be measured places markers at the upper and lower frequencies of the waveform representing the bandwidth utilized by that percentage of power.

Adjacent channel power (ACP)

Fast, accurate simultaneous filtered RMS power measurement of a carrier relative to its leakage in up to six offset bands or channels.

Simplify Common Measurement Tasks (continued)

Bench repair

An effective, professional bench repair tool

Most bench repair tasks demand fast, cost effective test solutions. Being small and lightweight, the N9320B spectrum analyzer is as functional and indispensable in low-cost bench repair applications as it is for field troubleshooting.

Detecting low signal levels while simultaneously resolving closely spaced frequencies is a fundamental requirement for RF testing. Employing one of the best combinations of sensitivity and narrow resolution bandwidths (RBW) ensures that an N9320B spectrum analyzer will readily handle these tasks.

Spectrum emission mask (SEM)

The spectrum emission mask (SEM) is a set of complex limit lines forming a mask for out-of-channel emissions measurement. The SEM is defined relatively to in-channel power. You can set the parameters of the main channel, out of channel frequency bands and the limit lines. Included is Pass/Fail testing for the overall spectrum emission mask and each individual out-of-channel frequency range.

Of course, you retain the flexibility to tailor each measurement task to your specific needs when necessary. And you'll find it easy to distinguish between signals having large level differences since the N9320B has one of the widest dynamic ranges for an analyzer in its price range.

High accuracy power measurements

The N9320B now supports high accuracy, USB plug-and-play power measurements as standard when connected to a Keysight U2000 series USB power sensor. Make true average power measurements for all signal types with wide dynamic range up to 18 GHz with just the push of a button. The Keysight U2000 series USB power sensors require no external power supplies and with internal zeroing eliminate the need for external calibration. Without the need for additional boxes, the user can easily set up, calibrate and control the power sensor via the analyzer's USB port. Two display modes are available: either the meter or the chart mode to log power measurements over time.



The combination of spectrum analyzer and power meter

Simplify Common Measurement Tasks (continued)

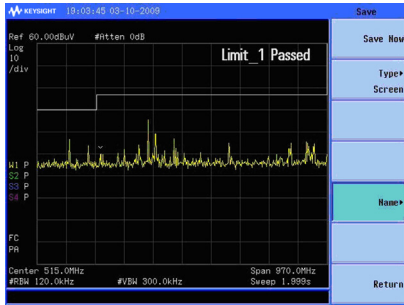

N9320B offers limit line for pass/fail

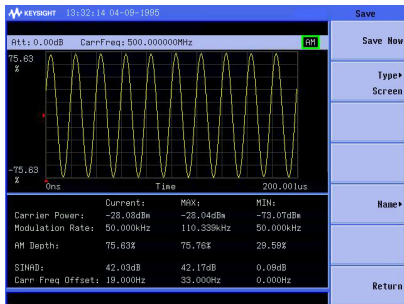

The detailed metrics provides you with the complete understanding of the AM signal

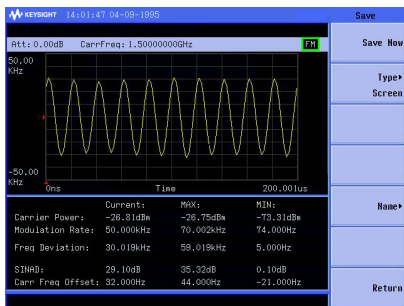

The detailed metrics provides you with the complete understanding of the FM signal

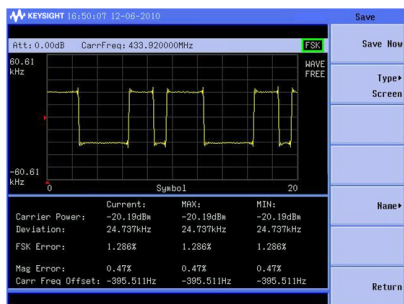

The FSK demodulation metrics with waveform view

EMI filters now available (Option EMF)

One of the critical steps for product development in order to sell electronic products on the commercial market, is they must pass EMC (Electro Magnetic Compatibility) requirements. Waiting until the end of the development cycle to find out whether or not a product passes regulatory agency requirements can be an expensive gamble. Failing to pass can result in costly redesign, delays while waiting for additional EMC compliance testing and results and postponement to your product introduction.

Therefore, it is important to perform EMI (Electro Magnetic Interference) pre-compliance (Electro Magnetic Interference) pre-compliance tests to find potential EMC problems during the product development phase, where they can be more easily corrected, and prior to sending your product to a regulatory agency or EMC test facility for final verification. Pre-compliance measurements are intended to give you an approximation of the EMI performance of your products. This can provide you with higher confidence in passing regulatory agency requirements.

Now, the N9320B provides you with optional CISPR EMI filters (-6 dB), covering resolution bandwidths 200 Hz, 9 kHz, 120 kHz and 1 MHz for enhancing pre-compliance measurements. Installing option EMF enables EMI pre-compliance measurements in CISPR-specified bandwidths and these tests can be made using the N9320B's positive peak detector in a simple and fast way.

AM/FM demodulation analysis (Option AMA)

When you are making modulation depth or frequency deviation measurements for AM or FM devices, the N9320B with its optional AM/FM modulation analysis shows the metrics you need, including carrier power, modulation rate, AM depth/FM deviation, SINAD and carrier frequency offset. User definable limits provide Pass/Fail indicators for carrier power, AM modulation index or FM deviation, and carrier frequency offset. The user can save the waveforms with metrics for reporting as well as the set-up parameters for future measurements or analysis.

Besides the AM/FM demodulation analysis (option AMA), the N9320B provides AM/FM tune and listen in spectrum analysis mode as a standard function.

ASK/FSK demodulation analysis (Option DMA)

Optional ASK/FSK modulation analysis is now available. Amplitude Shift Keying (ASK) is used in RFID and optical systems. Frequency Shift Keying (FSK) is used in many applications including cordless phone, paging systems and RFID. N9320B with option DMA supports four display modes: Symbol, Waveform, ASK/FSK Error, and Eye Diagram. Included is Pass/Fail testing for carrier power, ASK modulation depth/FSK frequency deviation. The metrics you need are shown, including carrier power, ASK/FSK error, ASK depth/FSK frequency deviation, and ASK index etc. For reports and future measurements the waveform with metrics and setup parameters can be saved.

When it comes to receiving the best return from your R&D equipment budget, turn to Keysight's new generation of low-cost analyzers and sources.

- Additional features that make spectrum analysis easier**
- Four traces and up to 12 markers allow optimum flexibility for complex troubleshooting in multi-signal environments
 - Marker table lists the frequency and amplitude matrix from all active markers, including delta markers
 - Frequency counter offers more accurate frequency readout
 - USB flash memory stick support provides quick save or recall of measurement data



Limited on your R&D budget?

You'll find an N9320B spectrum analyzer equally versatile for budget sensitive R&D applications. It is also suitable for RF design verification or when initiating a low cost project for product enhancements and extensions.

Wherever you deploy your engineering resources, they will find operating an N9320B spectrum analyzer easy to use.

The low displayed average noise floor and narrow resolution bandwidths provide optimum spectral visibility and resolution of small signals.

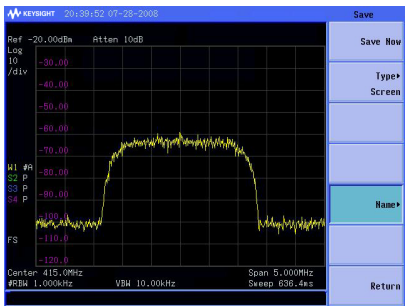

Scale indicator for quick vertical axis readout

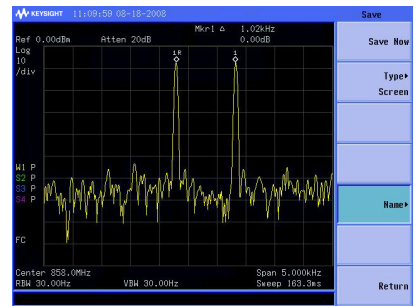

Narrow RBW clearly distinguishes two close-in signals

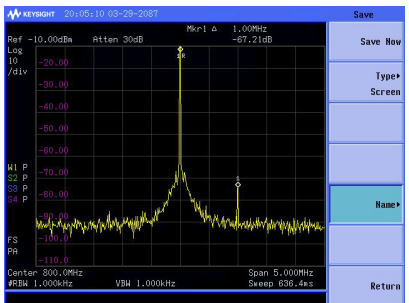

Easy to distinguish low level signal

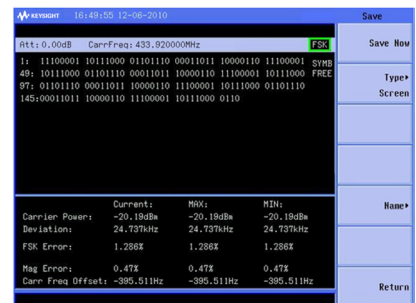

The FSK demodulation metrics with symbol view

Education

Teacher's special: Display projection

When you are ready to show frequency domain phenomena to your students or even the instrument operation, you may want to display the instrument screen in a larger format for all the students in the lab or classroom to observe. The N9320B supports VGA output and can display the instrument's screen on a larger monitor or video projector simultaneously.

Affordable, fast support

Buying test equipment from Keysight's new low-cost series puts you in touch with top-line service and support should you need it. So, you can be confident that you are making the right choice for the right price.



Whether you are mentoring your graduate students for completion of an important research project, or leading under-graduates in hands-on experiments in your campus electronics lab, using Keysight test equipment in your educational institution guarantees you are upholding the highest standards for the future of tomorrow's engineers.

Learning how to use test instrumentation, and understanding how RF signals interact are fundamental to the study of electronics. Spectrum analysis is essential to RF circuit design. It sheds an intuitive light on signal interactions and mixing processes for students.

The combination of the affordable price and performance in the N9320B spectrum analyzer, part of the low-cost test equipment series from Keysight Technologies, means that you do not need to limit students access to professional RF equipment in the classroom.

Now you have the opportunity to put Keysight's renowned quality and precision into every student's hands. Help your students and trainees gain the edge. There is no longer a need to compromise on the performance of their test equipment.

Educators hold Keysight test equipment in the highest esteem. Therefore, you can be confident of upholding high standards in the classroom and insure your students will have confidence in their experimental results. In addition, they will be able to focus more time on RF circuit experimentation and signal analysis exercises, because Keysight spectrum analyzer operation is straightforward.

You'll find the N9320B has sufficient performance for many basic research projects, where you need an inexpensive, fast, high-quality, general-purpose RF signal analyzer.

Education (continued)

Typical RF teaching lab solution

- N9320B: RF spectrum analyzer
- N9310A: RF signal generator
- N9320B-TR1: RF training kit

RF education solution from Keysight

One of the best ways to improve your students' learning efficiency for RF related curriculums is to combine teaching with hands-on labs. We also suspect you may want to save precious instructor time by leveraging an RF teaching lab that's already well designed and yet inexpensive. The N9320B spectrum analyzer and its educational kit (Ordering code: N9320B-TR1), together with Keysight's basic signal generator N9310A offer a new and systematic RF teaching environment for you and your students. You can design or deploy almost any RF circuit experiment for your students, from transmitters and receivers to key individual RF components, such as mixers, amplifier and filters.

The RF training kit consists of two boards. One acts as a TX circuit, another one acts as a RX circuit. The major RF components on each board can be separately used as standalone components. We designed the flexibility into the kit and you'll find using Keysight's RF education solution convenient, time saving and cost effective.

When you talk about the concept of frequency domain, carrier frequency and its harmonics or frequency selective power measurements, you can use the N9320B spectrum analyzer and N9310A RF signal generator as the basic configuration in your RF/microwave lab.

When you need to communicate the features of a typical RF circuit, such as the TX and RX paths, and how they deliver signals, simply use the RF training kit and its courseware to design an effective hands-on lab for your students. When your students need to take a closer look at those RF components, such as mixer, filters and amplifiers, the RF training kit allows you to separately utilize its individual components.

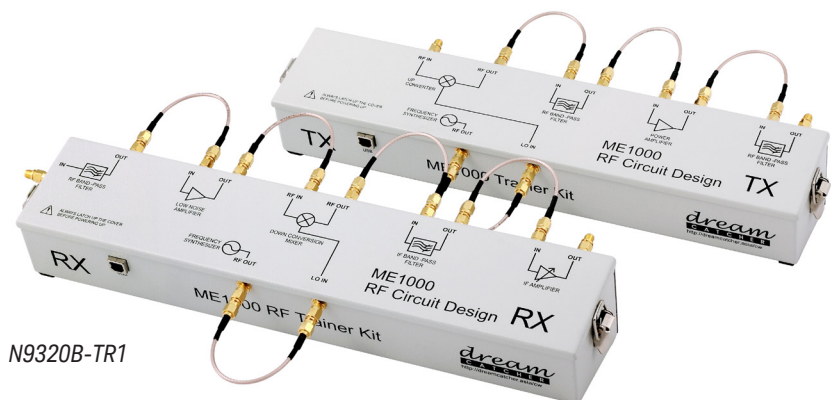

Evolving Since 1939

Our unique combination of hardware, software, services, and people can help you reach your next breakthrough. We are unlocking the future of technology.

From Hewlett-Packard to Agilent to Keysight.



myKeysight

myKeysight

www.keysight.com/find/mykeysight

A personalized view into the information most relevant to you.

http://www.keysight.com/find/emt_product_registration

Register your products to get up-to-date product information and find warranty information.

KEYSIGHT SERVICES

Accelerate Technology Adoption.
Lower costs.

Keysight Services

www.keysight.com/find/service

Keysight Services can help from acquisition to renewal across your instrument's lifecycle. Our comprehensive service offerings—one-stop calibration, repair, asset management, technology refresh, consulting, training and more—helps you improve product quality and lower costs.



Keysight Assurance Plans

www.keysight.com/find/AssurancePlans

Up to ten years of protection and no budgetary surprises to ensure your instruments are operating to specification, so you can rely on accurate measurements.

Keysight Channel Partners

www.keysight.com/find/channelpartners

Get the best of both worlds: Keysight's measurement expertise and product breadth, combined with channel partner convenience.

For more information on Keysight Technologies' products, applications or services, please contact your local Keysight office. The complete list is available at:

www.keysight.com/find/contactus

Americas

| | |
|---------------|------------------|
| Canada | (877) 894 4414 |
| Brazil | 55 11 3351 7010 |
| Mexico | 001 800 254 2440 |
| United States | (800) 829 4444 |

Asia Pacific

| | |
|--------------------|----------------|
| Australia | 1 800 629 485 |
| China | 800 810 0189 |
| Hong Kong | 800 938 693 |
| India | 1 800 11 2626 |
| Japan | 0120 (421) 345 |
| Korea | 080 769 0800 |
| Malaysia | 1 800 888 848 |
| Singapore | 1 800 375 8100 |
| Taiwan | 0800 047 866 |
| Other AP Countries | (65) 6375 8100 |

Europe & Middle East

| | |
|----------------|---------------|
| Austria | 0800 001122 |
| Belgium | 0800 58580 |
| Finland | 0800 523252 |
| France | 0805 980333 |
| Germany | 0800 6270999 |
| Ireland | 1800 832700 |
| Israel | 1 809 343051 |
| Italy | 800 599100 |
| Luxembourg | +32 800 58580 |
| Netherlands | 0800 0233200 |
| Russia | 8800 5009286 |
| Spain | 800 000154 |
| Sweden | 0200 882255 |
| Switzerland | 0800 805353 |
| | Opt. 1 (DE) |
| | Opt. 2 (FR) |
| | Opt. 3 (IT) |
| United Kingdom | 0800 0260637 |

For other unlisted countries:

www.keysight.com/find/contactus
(BP-9-7-17)

DEKRA Certified
ISO 9001 Quality Management System

www.keysight.com/go/quality

Keysight Technologies, Inc.
DEKRA Certified ISO 9001:2015
Quality Management System



This information is subject to change without notice.

© Keysight Technologies, 2017
Published in USA, December 2, 2017
5989-8800EN
www.keysight.com